



Precision Silicon Oscillators with Enable or Autoenable

General Description

The MAX7393/MAX7394 precision silicon oscillators replace crystals, ceramic resonators, and crystal oscillator modules in systems with a +2.4V to +3.6V operating supply voltage range.

The MAX7393/MAX7394 consist of a temperature-compensated precision oscillator with enable (MAX7394) or autoenable (MAX7393). The MAX7393/MAX7394 are supplied at specific frequencies, just like crystals and resonators. Output frequency accuracy is guaranteed to be within $\pm 0.25\%$ (TDFN) and $\pm 1.3\%$ (μ DFN) (0°C to $+85^{\circ}\text{C}$) and $\pm 1.0\%$ (TDFN) and $\pm 1.8\%$ (μ DFN) over the -40°C to $+125^{\circ}\text{C}$ temperature range.

The small size and robust operation of the MAX7393/MAX7394 make them ideal for space-constrained or environmentally demanding applications where high accuracy is required. The high accuracy of the MAX7393/MAX7394 is ideal for use in USB applications, computers, and white goods.

The MAX7393/MAX7394 are available in 6-pin, 3mm x 3mm TDFN and 2mm x 2mm μ DFN packages. They are specified for the -40°C to $+125^{\circ}\text{C}$ temperature range.

Applications

USB	Computers
CAN Nodes	Handheld Products
Automotive Systems	White Goods

Typical Application Circuits

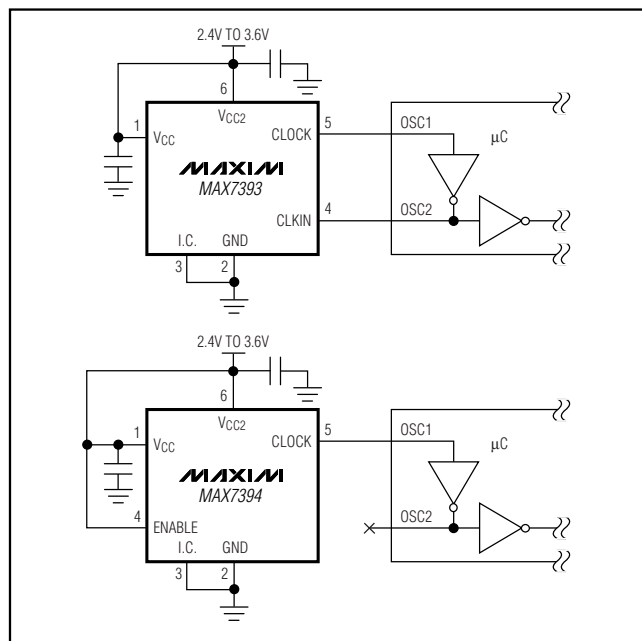

Features

- ◆ $\pm 0.25\%$ (TDFN) and $\pm 1.3\%$ (μ DFN) Total Accuracy for 0°C to $+85^{\circ}\text{C}$
- ◆ $\pm 1.0\%$ (TDFN) and $\pm 1.8\%$ (μ DFN) Total Accuracy for -40°C to $+125^{\circ}\text{C}$
- ◆ Resistant to Humidity and Vibration
- ◆ 12mA Operating Current (48MHz Version)
- ◆ 5ns Output Rise/Fall Time
- ◆ 40% to 60% Maximum Duty Cycle
- ◆ No External Components Required
- ◆ +2.4V to +3.6V Operation
- ◆ Available Factory-Set Frequencies from 922kHz to 48MHz
- ◆ Space-Saving TDFN and μ DFN Surface-Mount Packages

Ordering Information

PART*	TEMP RANGE	PIN-PACKAGE	PKG CODE
MAX7393ALT_+_	-40°C to $+125^{\circ}\text{C}$	6 μ DFN	L622-1
MAX7393ATT_+_	-40°C to $+125^{\circ}\text{C}$	6 TDFN	T633-1
MAX7394ALT_+_	-40°C to $+125^{\circ}\text{C}$	6 μ DFN	L622-1
MAX7394ATT_+_	-40°C to $+125^{\circ}\text{C}$	6 TDFN	T633-1

*The two-letter frequency suffix following the part number is found in the Selector Guide.

+Denotes lead-free package.

Note: The MAX7394 is available in factory-set frequencies from 922kHz to 48MHz. The MAX7393 is available in factory-set frequencies from 922kHz to 20MHz. There are 10 standard frequencies (see the Selector Guide) with a required 2.5k order increment. Nonstandard frequencies are also available with a required 10k order increment. For nonstandard versions, contact factory for availability and ordering information.

Selector Guide and Pin Configurations appear at end of data sheet.

MAX7393/MAX7394

Precision Silicon Oscillators with Enable or Autoenable

ABSOLUTE MAXIMUM RATINGS

V_{CC}, V_{CC2} to GND-0.3V to +4.0V
 CLOCK, CLKIN, ENABLE, I.C. to GND-0.3V to (V_{CC} + 0.3V)
 CLOCK Output Current±50mA
 Continuous Power Dissipation (T_A = +70°C)
 6-Pin µDFN (derate 4.5mW/°C over +70°C)358mW
 6-Pin TDFN (derate 18.2mW/°C over +70°C)1455mW

Operating Temperature Range-40°C to +125°C
 Junction Temperature+150°C
 Storage Temperature Range-65°C to +150°C
 Lead Temperature (soldering, 10s)+300°C

Stresses beyond those listed under "Absolute Maximum Ratings" may cause permanent damage to the device. These are stress ratings only, and functional operation of the device at these or any other conditions beyond those indicated in the operational sections of the specifications is not implied. Exposure to absolute maximum rating conditions for extended periods may affect device reliability.

ELECTRICAL CHARACTERISTICS

(V_{CC} = V_{CC2} = +2.4V to +3.6V, C_L = 10pF, T_A = -40°C to +125°C, unless otherwise noted. Typical values are at V_{CC} = V_{CC2} = +3.3V, T_A = +25°C, unless otherwise noted.) (Note 1)

PARAMETER	SYMBOL	CONDITIONS	MIN	TYP	MAX	UNITS
DC CHARACTERISTICS						
Operating Supply Voltage	V _{CC}		2.4		3.6	V
Operating Output Supply Voltage	V _{CC2}		2.4		3.6	V
Total Operating Supply Current (Note 2)	I _{TOT}	922kHz, MAX739_ _ _ _LY			4.4	mA
		4MHz, MAX739_ _ _ _RD			5.4	
		8MHz, MAX739_ _ _ _TP			5.8	
		16MHz, MAX739_ _ _ _WB			6.5	
		32MHz, MAX7394_ _ _ _YN			9.2	
		33MHz, MAX7394_ _ _ _YQ			9.5	
		48MHz, MAX7394_ _ _ _ZY			12	
Total Shutdown Supply Current	I _{SHDN}	Oscillator disabled, CLKIN = high (MAX7393), ENABLE = low (MAX7394) (Note 2)		1	2	µA
LOGIC INPUTS (ENABLE, CLKIN)						
Logic Input High Voltage	V _{IH}		0.7 x V _{CC2}			V
Logic Input Low Voltage	V _{IL}				0.3 x V _{CC2}	V
CLOCK OUTPUT						
Output High Voltage	V _{OH}	V _{CC2} ≥ 2.4V, I _{SOURCE} = 5mA	V _{CC2} - 0.3			V
Output Low Voltage	V _{OL}	V _{CC2} ≥ 2.4V, I _{SINK} = 5mA			0.3	V
Output Rise Time	t _R	(Note 3)		5		ns
Output Fall Time	t _F	(Note 3)		5		ns
Duty Cycle		(Note 3)		47		%
Startup Time		Time for output to stabilize		2		ms
Output Jitter (Note 3)		Peak-to-peak jitter, 16MHz (MAX7394)		180		ps
		Peak-to-peak jitter, 48MHz (MAX7394)		140		

Precision Silicon Oscillators with Enable or Autoenable

MAX7393/MAX7394

ELECTRICAL CHARACTERISTICS (continued)

($V_{CC} = V_{CC2} = +2.4V$ to $+3.6V$, $C_L = 10pF$, $T_A = -40^{\circ}C$ to $+125^{\circ}C$, unless otherwise noted. Typical values are at $V_{CC} = V_{CC2} = +3.3V$, $T_A = +25^{\circ}C$, unless otherwise noted.) (Note 1)

PARAMETER	SYMBOL	CONDITIONS		MIN	TYP	MAX	UNITS
FREQUENCY ACCURACY							
Clock Frequency Coefficient of Temperature		$V_{CC} = V_{CC2} = 3.3V$	$T_A = 0^{\circ}C$ to $+70^{\circ}C$		± 20		ppm/ $^{\circ}C$
			$T_A = -40^{\circ}C$ to $+125^{\circ}C$		± 50		
Clock Frequency Coefficient of Supply Voltage		$T_A = +25^{\circ}C$			0.1	0.15	%/V
Total Accuracy		$V_{CC} = V_{CC2} = 3.3V$	$T_A = 0^{\circ}C$ to $+85^{\circ}C$, $V_{CC} = \pm 10\%$	TDFN (Note 4)		± 0.25	%
				μ DFN (Note 5)		± 1.3	
			$T_A = -40^{\circ}C$ to $+125^{\circ}C$, $V_{CC} = \pm 10\%$	TDFN (Note 4)		± 1.0	
				μ DFN (Note 5)		± 1.8	

Note 1: All parameters are production tested at $T_A = +25^{\circ}C$. Specifications over temperature are guaranteed by design and characterization.

Note 2: The total supply current is the sum of I_{CC} and I_{CC2} .

Note 3: Guaranteed by design and characterization. Not production tested.

Note 4: Output frequency is production tested at $T_A = +25^{\circ}C$ and $T_A = +85^{\circ}C$.

Note 5: Output frequency is production tested at $T_A = +25^{\circ}C$.

Precision Silicon Oscillators with Enable or Autoenable

Typical Operating Characteristics

($V_{CC} = V_{CC2} = 3.3V$, $T_A = +25^\circ C$, MAX7394, 48MHz output, unless otherwise noted.)

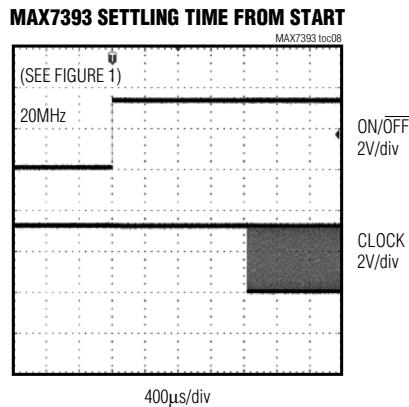
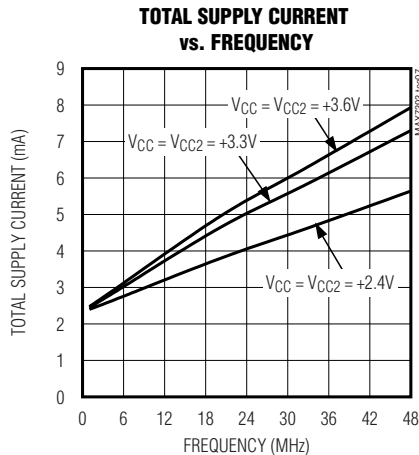
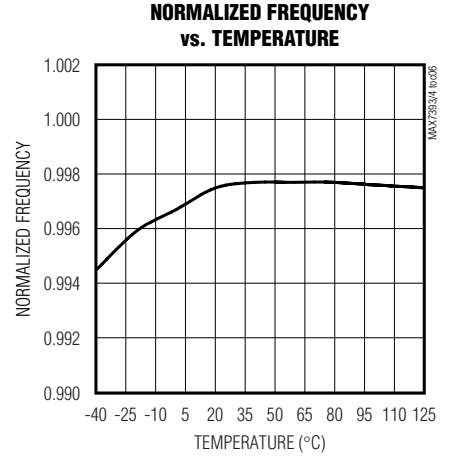
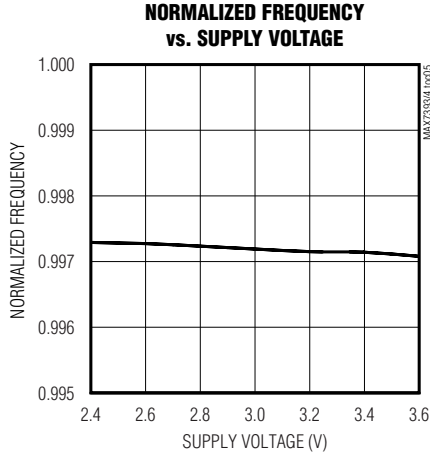
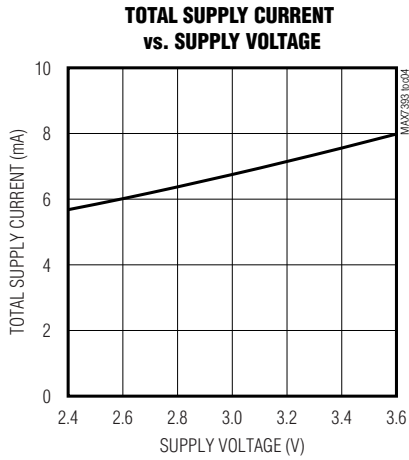
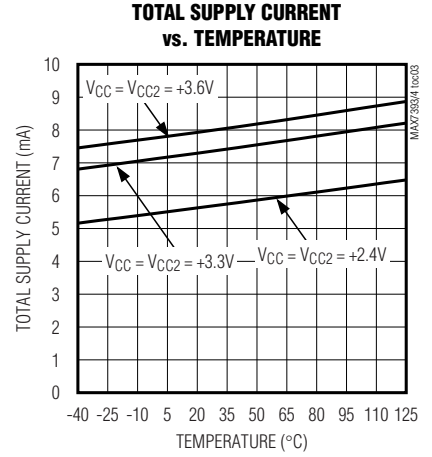
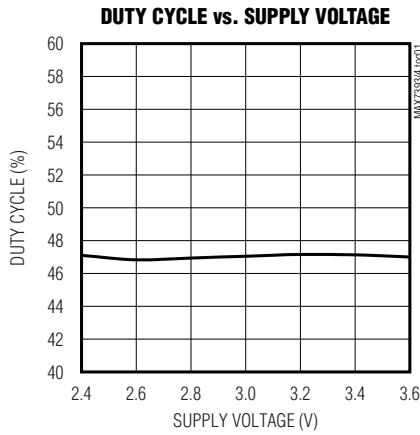
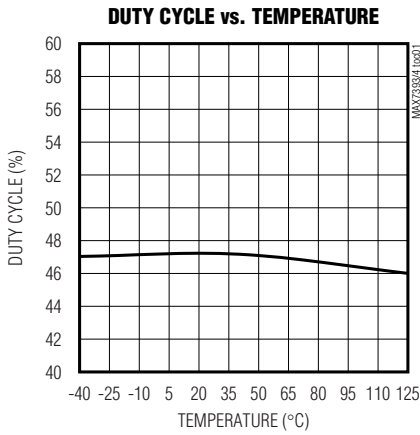

Precision Silicon Oscillators with Enable or Autoenable

Typical Operating Characteristics (continued)

($V_{CC} = V_{CC2} = 3.3V$, $T_A = +25^\circ C$, MAX7394, 48MHz output, unless otherwise noted.)

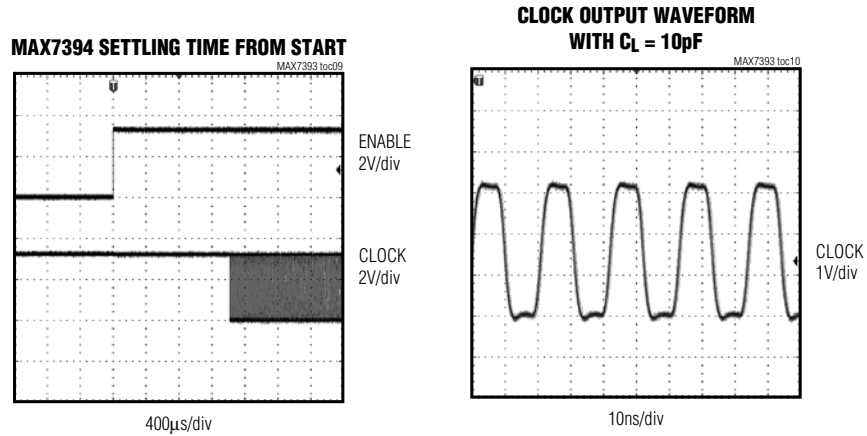

MAX7393/MAX7394

Pin Description

PIN		NAME	FUNCTION
MAX7393	MAX7394		
1	1	V_{CC}	Positive Supply Voltage Input. Bypass V_{CC} to GND with 0.1µF capacitors placed as close to the device as possible. Connect V_{CC} to V_{CC2} .
2	2	GND	Ground
3	3	I.C.	Internally Connected. Connect I.C. to GND. Do not connect I.C. to any other input or output. Do not leave I.C. unconnected.
4	—	CLKIN	Clock Input. Connect CLKIN to a returned clock signal source (see the <i>Autoenable (CLKIN, MAX7393)</i> section).
5	5	CLOCK	Clock Output. CLOCK is a rail-to-rail, push-pull output.
6	6	V_{CC2}	Positive Supply Voltage Input for Output Driver. Bypass V_{CC2} to GND with a 0.1µF capacitor placed as close to the device as possible. Connect V_{CC2} to V_{CC} .
—	4	ENABLE	Enable Input. Drive ENABLE low to place the MAX7394 in shutdown mode. Drive ENABLE high for normal operation.
—	—	EP	Exposed Paddle, TDFN Version Only. Connect EP to ground. Do not connect EP to any other input or output.

Precision Silicon Oscillators with Enable or Autoenable

Detailed Description

The MAX7393/MAX7394 precision silicon oscillators replace crystals, ceramic resonators, and crystal oscillator modules in systems with a +2.4V to +3.6V operating supply voltage range. The MAX7393/MAX7394 consist of a temperature-compensated precision oscillator with enable (MAX7394) or autoenable (MAX7393). The ENABLE input on the MAX7394 manually enables or disables the oscillator. The CLKIN input on the MAX7393 monitors a returned clock signal to automatically enable or disable the MAX7393 oscillator.

The MAX7393/MAX7394 are supplied at specific frequencies, like crystals and resonators. A variety of popular standard frequencies are available (see the *Selector Guide*). Output frequency accuracy is guaranteed to be within $\pm 0.25\%$ (TDFN) and $\pm 1.3\%$ (μ DFN) (0°C to $+85^{\circ}\text{C}$) and $\pm 1.0\%$ (TDFN) and $\pm 1.8\%$ (μ DFN) over the -40°C to $+125^{\circ}\text{C}$ temperature range. No external components are required to generate the specific frequency.

ENABLE (MAX7394)

The ENABLE input on the MAX7394 turns the oscillator on and off. Drive ENABLE to a logic-high for normal operation. Drive ENABLE to a logic-low to place the device in shutdown mode. During shutdown, the oscillator is turned off, and the CLOCK output is weakly driven high with an internal $10\text{k}\Omega$ to V_{CC2} . In shutdown mode, the total supply current reduces to less than $2\mu\text{A}$.

Autoenable (CLKIN, MAX7393)

The MAX7393 features a CLKIN input that automatically enables or disables the oscillator by sensing the condition of a returned clock signal. The MAX7393 is automatically enabled whenever an active inversion function is sensed between CLOCK and CLKIN. When no inversion function is detected, the MAX7393 automatically enters shutdown mode. During shutdown, the oscillator is turned off, the CLKIN input is weakly driven to its last state, and the CLOCK output is weakly driven to the logic-level in CLKIN.

The CLKIN input relies on an external inversion function, typically provided by a microcontroller's clock generator, to provide an inverted version of the CLOCK output signal. The MAX7393 interprets high/low voltage or a constant high-impedance node on CLKIN as a disable signal.

Figure 1 shows a test circuit to enable or disable the MAX7393. One input of the NAND gate connects to the CLOCK output of the MAX7393, and the other input is driven with a logic level. A logic-high level enables the oscillator and a logic-low level disables the oscillator. See the *Typical Operating Characteristics* for typical startup performance of the MAX7393.

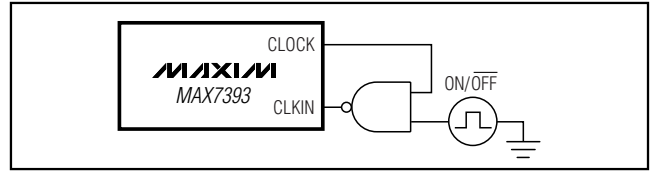

Figure 1. Test Circuit to Enable or Disable the MAX7393 Oscillator

Oscillator (CLOCK)

The CLOCK output is a push-pull, CMOS logic output that is capable of driving a ground-connected $1\text{k}\Omega$ load or a positive supply connected 500Ω load to within 300mV of either supply rail. There are no impedance-matching issues when using the MAX7393/MAX7394 CLOCK output. A typical startup characteristic is shown in the *Typical Operating Characteristics*.

Output Jitter

The MAX7393/MAX7394s' jitter performance is given in the *Electrical Characteristics* table as a peak-to-peak value.

Applications Information

Interfacing to a Microcontroller Clock Input

The MAX7393/MAX7394 CLOCK output is a push-pull, CMOS logic output that directly drives any microprocessor (μP) or microcontroller (μC) clock input. There are no impedance-matching issues when using the MAX7393/MAX7394. Operate the MAX7393/MAX7394 and microcontroller from the same supply voltage level of V_{CC2} (see the *Power-Supply Considerations* section for more details). Refer to the microcontroller's data sheet for clock input compatibility with external clock signals.

The MAX7393/MAX7394 require no biasing components or load capacitance. When using the MAX7393/MAX7394 to retrofit a crystal oscillator, remove all biasing components from the oscillator input.

Power-Supply Considerations

The MAX7393/MAX7394 operate with power-supply voltages in the +2.4V to +3.6V range. Connect V_{CC} and V_{CC2} to the same supply voltage level as the device receiving the clock. Proper power-supply decoupling is required to maintain the power-supply rejection performance of the MAX7393/MAX7394. Connect $0.1\mu\text{F}$ surface-mount ceramic capacitors from V_{CC} to V_{CC2} and V_{CC2} to GND. Position these bypass capacitors as close to V_{CC} and V_{CC2} as possible.

A larger V_{CC2} bypass capacitor value is recommended if the MAX7393/MAX7394 are to operate with a large capacitive load. Use a bypass capacitor value on V_{CC2} at least 1000 times that of the output load capacitance.

Precision Silicon Oscillators with Enable or Autoenable

Pin Configurations

TOP VIEW OF
BOTTOM LEADS

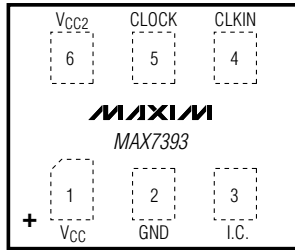

μDFN

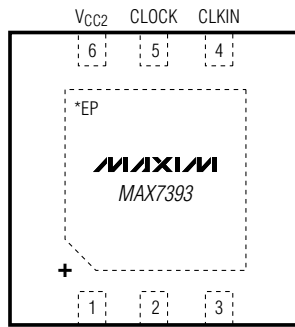

TDFN

*EXPOSED PADDLE. CONNECT EP TO GROUND.

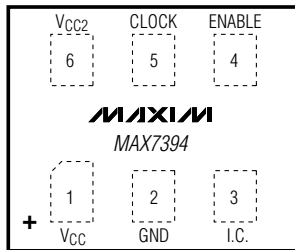

μDFN

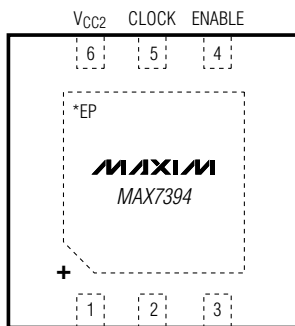

TDFN

*EXPOSED PADDLE. CONNECT EP TO GROUND.

Selector Guide

PART	FREQUENCY	PACKAGE	TOP MARK
MAX7393ATTLY	922kHz	6 TDFN	+ANP
MAX7393ALTLY	922kHz	6 μDFN	+ABO
MAX7393ATTMG	1MHz	6 TDFN	+ANQ
MAX7393ALTMG	1MHz	6 μDFN	+ABP
MAX7393ATTRD	4MHz	6 TDFN	+ANR
MAX7393ALTRD	4MHz	6 μDFN	+ABQ
MAX7393ATTTP	8MHz	6 TDFN	+ANS
MAX7393ALTTP	8MHz	6 μDFN	+ABR
MAX7393ATTWB	16MHz	6 TDFN	+AMN
MAX7393ALTWB	16MHz	6 μDFN	+AAR
MAX7393ATTWV	20MHz	6 TDFN	+AMO
MAX7393ALTWV	20MHz	6 μDFN	+AAS
MAX7394ATTLY	922kHz	6 TDFN	+ANV
MAX7394ALTLY	922kHz	6 μDFN	+ABU
MAX7394ATTMG	1MHz	6 TDFN	+ANW
MAX7394ALTMG	1MHz	6 μDFN	+ABV
MAX7394ATTRD	4MHz	6 TDFN	+ANX
MAX7394ALTRD	4MHz	6 μDFN	+ABW
MAX7394ATTTP	8MHz	6 TDFN	+ANY
MAX7394ALTTP	8MHz	6 μDFN	+ABX
MAX7394ATTWB	16MHz	6 TDFN	+AMU
MAX7394ALTWB	16MHz	6 μDFN	+AAV
MAX7394ATTWV	20MHz	6 TDFN	+AMV
MAX7394ALTWV	20MHz	6 μDFN	+AAZ
MAX7394ATTYN	32MHz	6 TDFN	+ANZ
MAX7394ALTYN	32MHz	6 μDFN	+ABY
MAX7394ATTYQ	33MHz	6 TDFN	+AMX
MAX7394ALTYQ	33MHz	6 μDFN	+ABB
MAX7394ATTZH	40MHz	6 TDFN	+AOA
MAX7394ALTZH	40MHz	6 μDFN	+ABZ
MAX7394ATTZY	48MHz	6 TDFN	+AMZ
MAX7394ALTZY	48MHz	6 μDFN	+ABD

Chip Information

PROCESS: BiCMOS

MAX7393/MAX7394

Precision Silicon Oscillators with Enable or Autoenable

Package Information

(The package drawing(s) in this data sheet may not reflect the most current specifications. For the latest package outline information, go to www.maxim-ic.com/packages.)

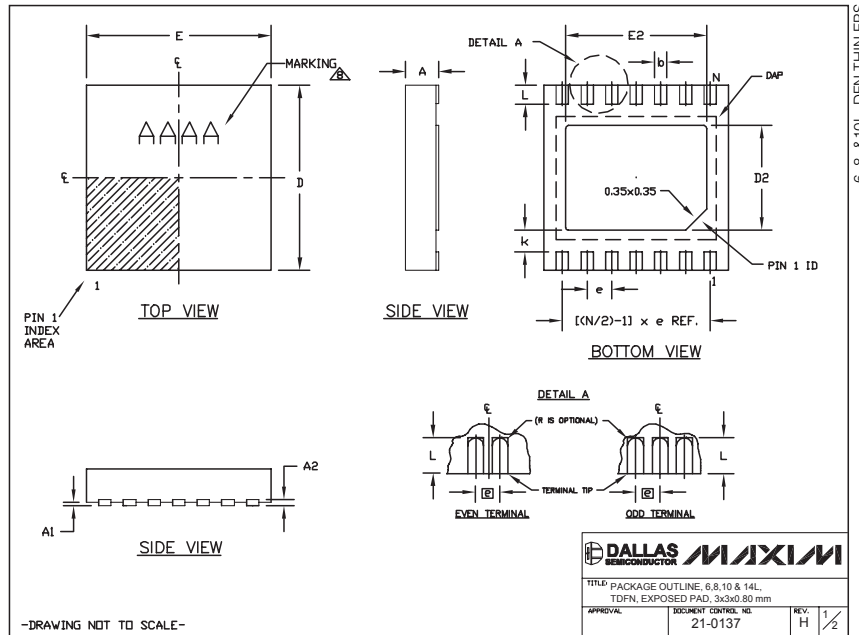

COMMON DIMENSIONS		
SYMBOL	MIN.	MAX.
A	0.70	0.80
D	2.90	3.10
E	2.90	3.10
A1	0.00	0.05
L	0.20	0.40
k	0.25 MIN.	
A2	0.20 REF.	

PACKAGE VARIATIONS							
PKG. CODE	N	D2	E2	e	JEDEC SPEC	b	[(N2)-1] x e
T633-1	6	1.50±0.10	2.30±0.10	0.95 BSC	MO229 / WEEA	0.40±0.05	1.90 REF
T633-2	6	1.50±0.10	2.30±0.10	0.95 BSC	MO229 / WEEA	0.40±0.05	1.90 REF
T833-1	8	1.50±0.10	2.30±0.10	0.65 BSC	MO229 / WEEC	0.30±0.05	1.95 REF
T833-2	8	1.50±0.10	2.30±0.10	0.65 BSC	MO229 / WEEC	0.30±0.05	1.95 REF
T833-3	8	1.50±0.10	2.30±0.10	0.65 BSC	MO229 / WEEC	0.30±0.05	1.95 REF
T1033-1	10	1.50±0.10	2.30±0.10	0.50 BSC	MO229 / WEED-3	0.25±0.05	2.00 REF
T1033-2	10	1.50±0.10	2.30±0.10	0.50 BSC	MO229 / WEED-3	0.25±0.05	2.00 REF
T1433-1	14	1.70±0.10	2.30±0.10	0.40 BSC	----	0.20±0.05	2.40 REF
T1433-2	14	1.70±0.10	2.30±0.10	0.40 BSC	----	0.20±0.05	2.40 REF

- NOTES:
- ALL DIMENSIONS ARE IN mm. ANGLES IN DEGREES.
 - COPLANARITY SHALL NOT EXCEED 0.08 mm.
 - WARPAGE SHALL NOT EXCEED 0.10 mm.
 - PACKAGE LENGTH/PACKAGE WIDTH ARE CONSIDERED AS SPECIAL CHARACTERISTIC(S).
 - DRAWING CONFORMS TO JEDEC MO229, EXCEPT DIMENSIONS "D2" AND "E2", AND T1433-1 & T1433-2.
 - "N" IS THE TOTAL NUMBER OF LEADS.
 - NUMBER OF LEADS SHOWN ARE FOR REFERENCE ONLY.
 - MARKING IS FOR PACKAGE ORIENTATION REFERENCE ONLY.

-DRAWING NOT TO SCALE-

DALLAS SEMICONDUCTOR **MAXIM**

TITLE: PACKAGE OUTLINE, 6, 8, 10 & 14L, DFN, EXPOSED PAD, 3x3x0.80 mm

APPROVAL: _____ DOCUMENT CONTROL NO. 21-0137 REV. H 2/2

Precision Silicon Oscillators with Enable or Autoenable

Package Information (continued)

(The package drawing(s) in this data sheet may not reflect the most current specifications. For the latest package outline information, go to www.maxim-ic.com/packages.)

MAX7393/MAX7394

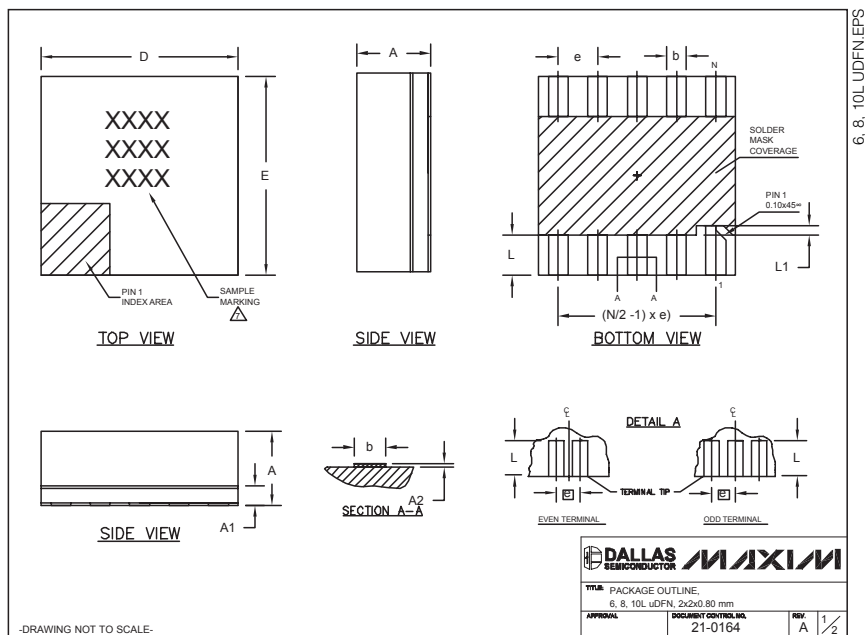

Maxim cannot assume responsibility for use of any circuitry other than circuitry entirely embodied in a Maxim product. No circuit patent licenses are implied. Maxim reserves the right to change the circuitry and specifications without notice at any time.

Maxim Integrated Products, 120 San Gabriel Drive, Sunnyvale, CA 94086 408-737-7600 _____ **9**